

Ultra Small Surface Mount Coaxial Connectors – 1.4mm Mated Height

W.FL Series – Further downsizing of FL series in response to the market needs.

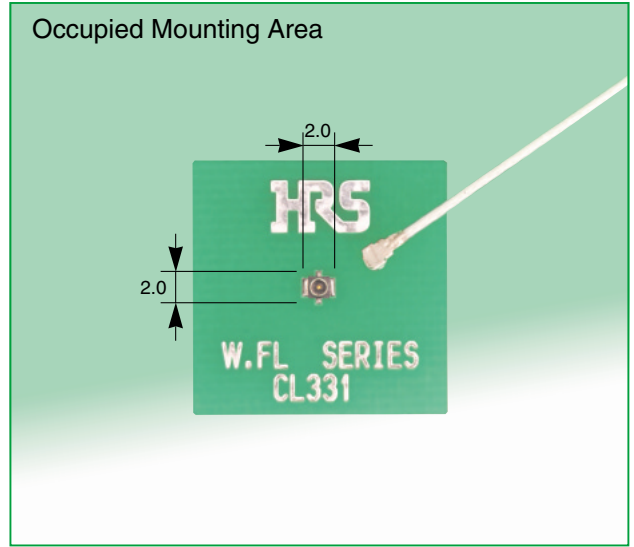
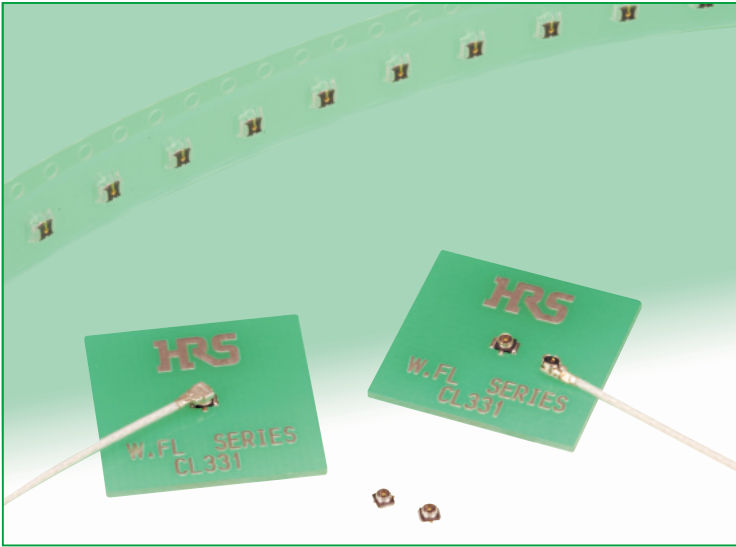

Features

1. Mounting area of only 3.4mm²
2. The board mounted receptacle weights only 5.6 mg
3. Accepts high frequency transmission of DC to 6GHz
4. Receptacle supplied on tape-and-reel for placement on the board with automatic equipment
5. Plugs are terminated with ultra-fine Teflon® insulated coaxial cables
6. Un-mating with a simple tool

Applications

Mobile phones, Wireless LAN, Bluetooth protocol devices, PDA, GPS, electronic measuring instruments and any application requiring high frequency transmission over coaxial line, where space is limited.

Mated Height Comparison(With U.FL series)

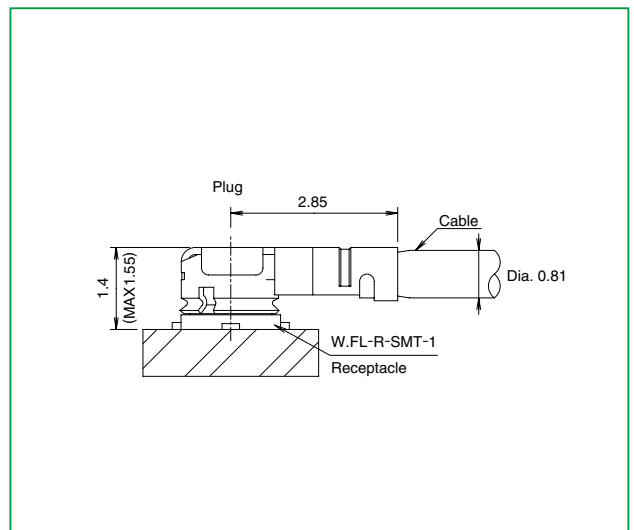
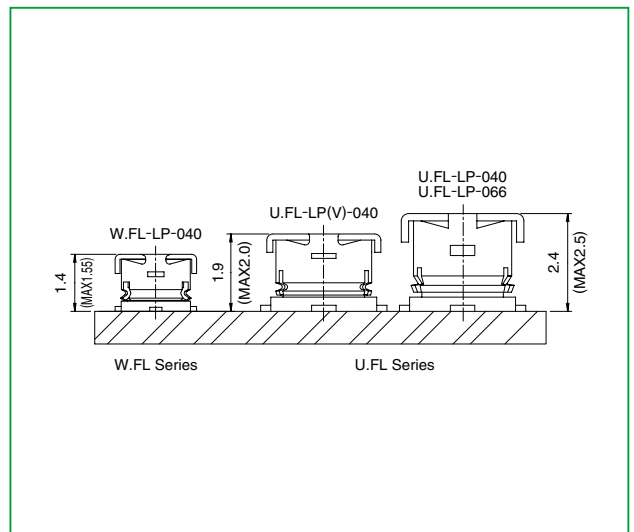

* Teflon is a registered trademark of DuPont.

Product Specifications

Ratings	Nominal characteristic impedance	50 ohms	Operating temperature range	-40°C to +90°C (Relative humidity 90% max.)
	Frequency range	DC to 6GHz	Operating humidity	-40°C to +70°C (Relative humidity 90% max.)

Materials and Finishes

Item	Specification
1. Contact resistance	Center: 20m ohms max. Outside: 10m ohms max.
2. Insulation resistance	500M ohms min., 100V DC
3. Withstanding voltage	200V AC / 1 minute
4. V.S.W.R.(Note)	1.3 max. (Up to 3GHz)
	1.35 max. (3 to 6GHz)

Note:V.S.W.R. Measurement System
 Measured as shown on the block diagram below.
 Test connection and measurement setup.

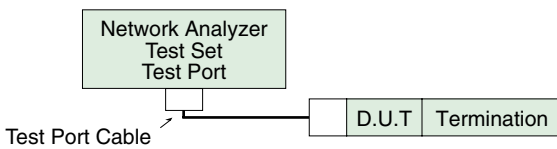

Note1:Cable type connector measurements.

With SMA conversion adapters mated with W.FL plug at each end of the 100cm long ultra-fine coaxial cable.

Note2:Board type connector measurements.

Mounted on a 50 ohms glass epoxy board. Measurements were conducted with SMA conversion adapters attached.

Material/Finishes

Part	Component	Material	Finish/Remarks
Plug	Shell	Phosphor bronze	Silver plated
	Insulator	PBT	Black, UL94V-0
	Socket center contact	Phosphor bronze	Gold plated
Receptacle	Shell	Phosphor bronze	Silver plated
	Insulator	LCP	Black, UL94V-0
	Pin center contact	Brass	Gold plated

Plug

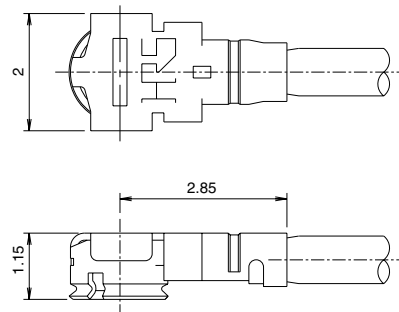
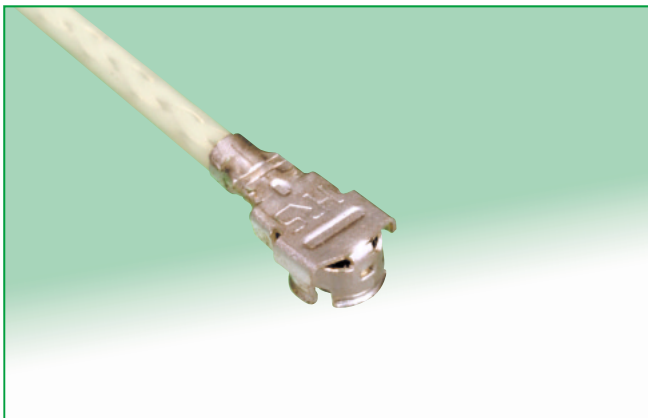

Plugs can be ordered only terminated to the cable.

How to Specify Cable Assembly

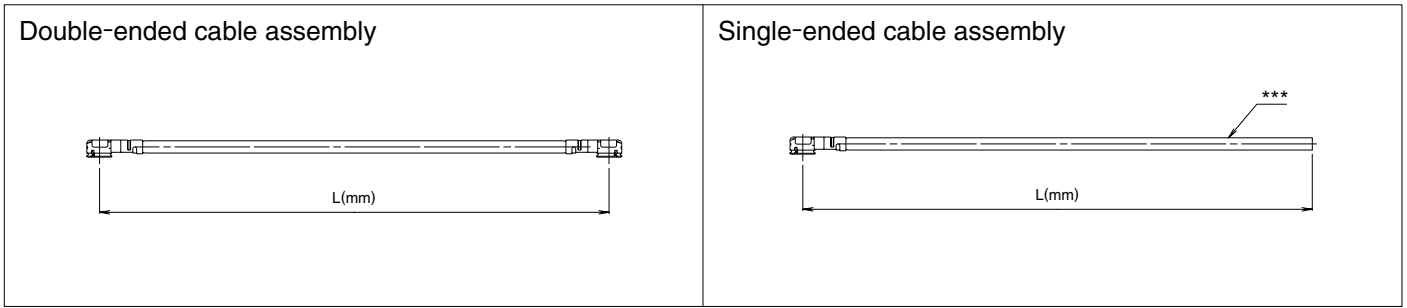

Ordering Information

W.FL - 2LP - 04N [] - A - (L)

① ② ③ ④ ⑤

① Series name	W.FL
② Assembly type	LP : Single ended 2LP: Double ended
③ Cable type	04N: 0.81mm dia. ultra-fine coaxial cable
④ Cable color	1: White, 2: Black
⑤ Total length (mm)	Length (L)

Standard tolerances for (L)**

(L)(mm)	Standard Tolerance (mm)
*L=35 to 200	±4
L=200 to 500	±8
L=500 to 1000	±12
L=1000 →	±1.5% of (L)

*Minimum available length (L) is 35mm

**Contact nearest HRS representative if different tolerances are required.

***Contact Nearest HRS representative if one end requires preparation.

Receptacle

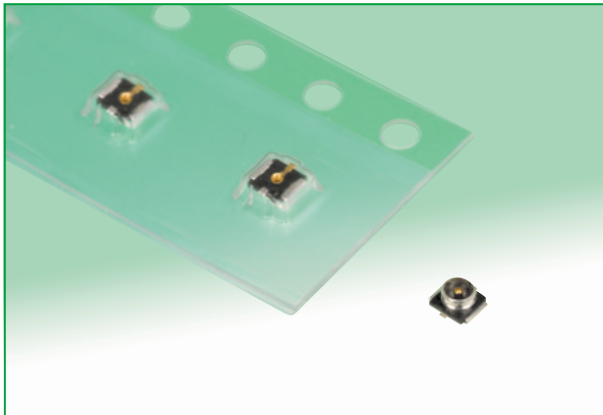

Recommended PCB Mounting Pattern

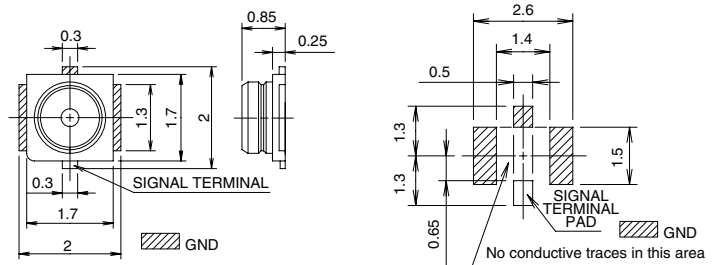

Recommended screen thickness: 0.1mm to 0.12mm

Part Number	CL No.	Packaging	Weight / EA
W.FL-R-SMT-1(10)	331-0482-6-10	Reel packaging (2000 pieces/reel)	5.6 mg

Conversion Adapters

● SMA Conversion Adapter (W.FL side jack – SMA side plug)

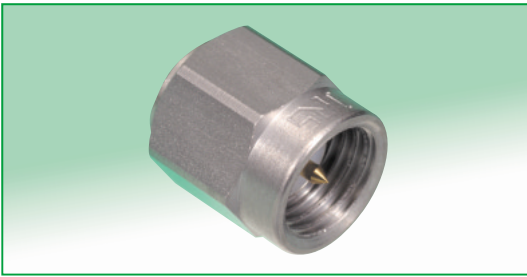

Note:Used for performance measurements only.
 The W.FL mating side has lower retention force than the regular product when mated to the corresponding part.

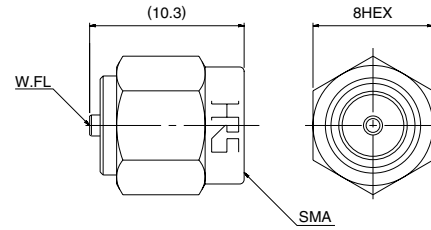

Part No.	CL No.
HRMP-W.FLJ	311-0367-3

● SMA Conversion Adapter (W.FL side plug – SMA side jack)



Note:Used for performance measurements only.
 The W.FL mating side has lower retention force than the regular product when mated to the corresponding part.

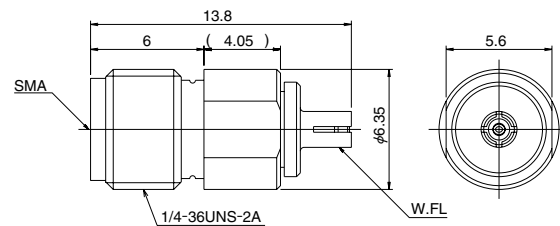

Part No.	CL No.
HRMJ-W.FLP	311-0368-6

● SMA Conversion Adapter



Note:When mating with corresponding part (W.FL-R-SMT-1) it must be pressed down and held to make complete connection.

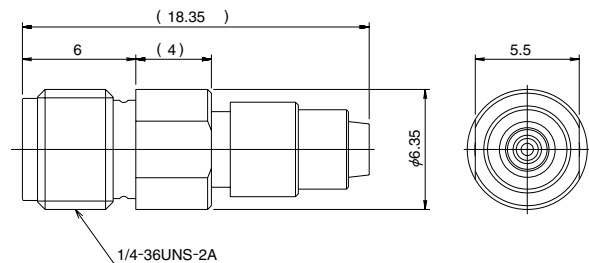

Part No.	CL No.
HRMJ-W.FLP-ST1	311-0386-8

Receptacle Inspection Adapter

● Used for inspecting the performance parameters of the cable assembly.

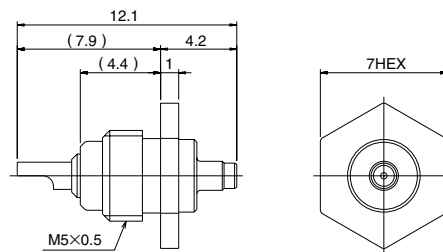
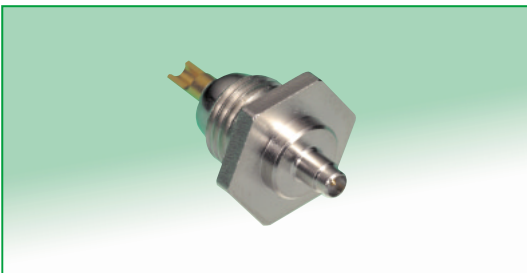

Part No.	CL No.
W.FL-R-1	331-0483-9

■ Plug Extraction Tool-Used for Un-mating of the plug

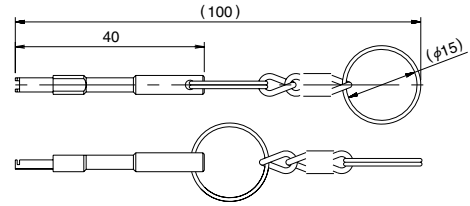

Part No.	CL No.
W.FL-LP-N	331-0492-0

◆ Packaging Specifications- Receptacle

W.FL-R-SMT-1(10)

Embossed Carrier Tape Dimensions

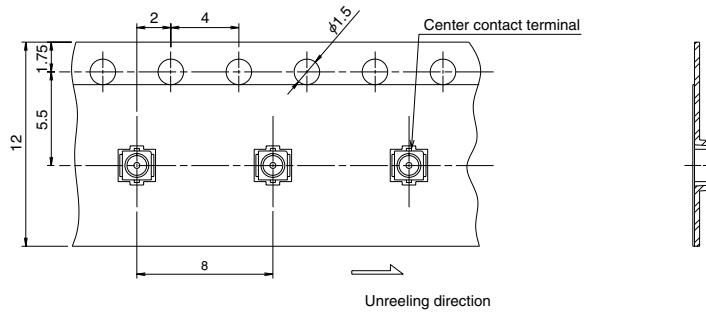

Reel Dimensions

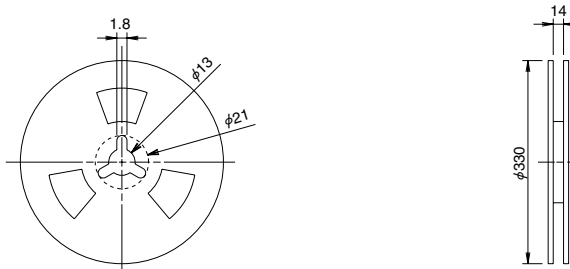

Usage Precautions

1. Plugs

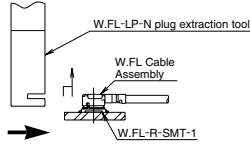
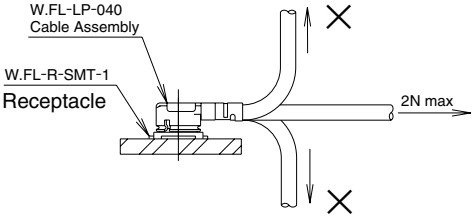
<p>(1) Mating/ un-mating</p>	<p>1) Mating. Both parts must be aligned on the axis to mate correct. Press down firmly. A tactile “click” will confirm fully mated condition.</p> <p>2) Un-mating. Fully insert the tool under the plug’s flanges as shown. Apply even force upward until the plug is free.</p> 
<p>(2) Cable handling</p>	<p>Do not twist, apply excessive forces or sharp bends to the cable.</p> 
<p>(3) Precautions</p>	<p>Do NOT forcefully twist or deform wires.</p>

2. Receptacles

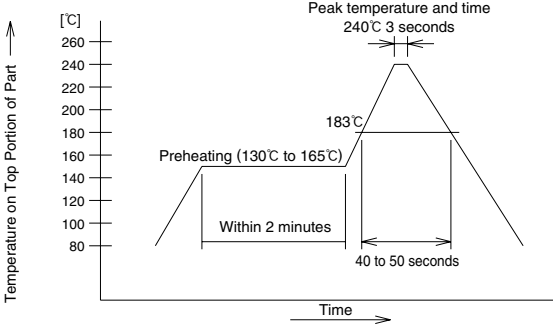
<p>(1) Recommended soldering temperature profile</p>	 <p>1) The temperature profile indicates the board surface temperature at the point of contacts with the connector terminals.</p> <p>2) The temperature may vary, depending on the board size, the solder paste type and thickness.</p>
<p>(2) Recommended screen thickness</p>	<p>0.1 to 0.12 mm</p>



HIROSE ELECTRIC CO.,LTD.

5-23,OSAKI 5-CHOME,SHINAGAWA-KU,TOKYO 141-8587,JAPAN
 PHONE: 81-3-3491-9741, FAX: 81-3-3493-2933
<http://www.hirose.com>
<http://www.hirose-connectors.com>